



acessórios

10A

 freitas irmãos,lda.

ACESSÓRIOS DIVERSOS



TIC TAC - M

TAB.	TIPO	REF.	ACAB.
C10A.01	C/ BATEENTE	TT_M_CB_14_BR	Branco
C10A.02		TT_M_CB_14_CZ	Cinza
C10A.03	MAGNÉTICO	TT_M_MAG_14_BR	Branco
C10A.04		TT_M_MAG_14_CZ	Cinza
C10A.05		TT_ANILHA	Zincado

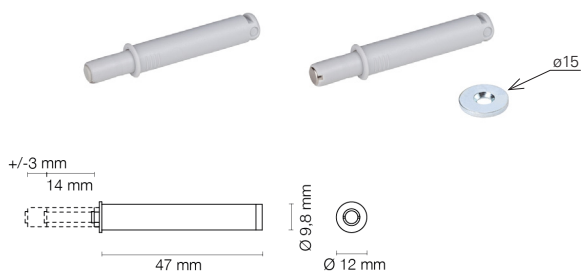

TIC TAC - XL

TAB.	TIPO	REF.	ACAB.
C10A.06	C/ BATEENTE	TT_XL_CB_37_BR	Branco
C10A.07		TT_XL_CB_37_CZ	Cinza
C10A.08	MAGNÉTICO	TT_XL_MAG_37_BR	Branco
C10A.09		TT_XL_MAG_37_CZ	Cinza
C10A.05		TT_ANILHA	Zincado

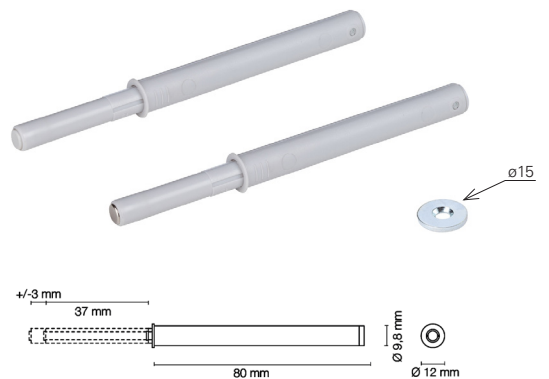

SUPORTE PARA TIC TAC

TAB.	REF.	MEDIDA	ACAB.
C10A.10	TT_SUP_M_BR	M - 58,5x14x15 alt.	Branco
C10A.11	TT_SUP_M_CZ		Cinza
C10A.12	TT_SUP_XL_BR	XL - 89x14x15 alt.	Branco
C10A.13	TT_SUP_XL_CZ		Cinza

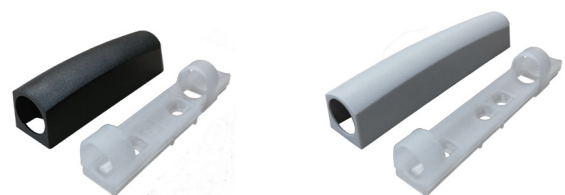

TAPETES ANTI-DESLIZANTES

TAPETE ANTI-DESLIZANTE

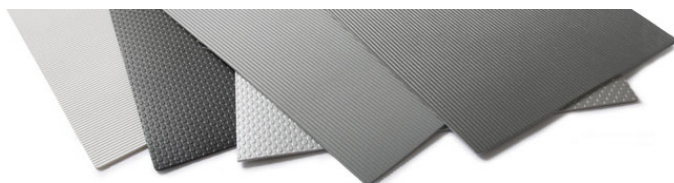

TAB.	ESPESSURA	ROLO		ACAB.
		LARG.	COMP.	
C10A.14	1,2mm	480mm	20m	Cinza
C10A.15	1,2mm	473mm	20m	

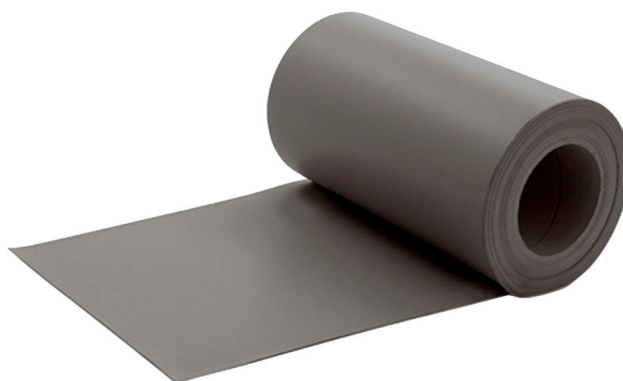
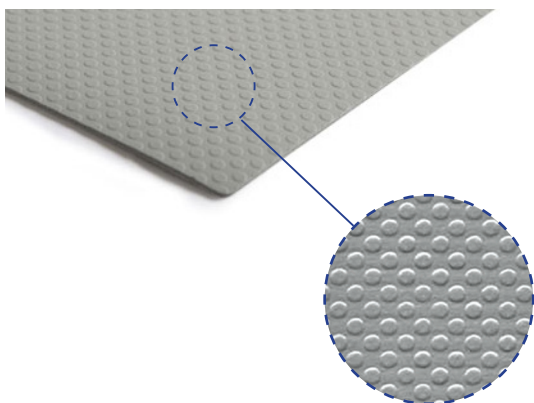

TAPETE C/ ACABAMENTO TÊXTEL

TAB.	ESPESSURA	ROLO		ACAB.
		LARG.	COMP.	
C10A.16	1,2mm	473mm	20m	Branco Cinza
C10A.17	1,2mm	480mm	20m	Antracite

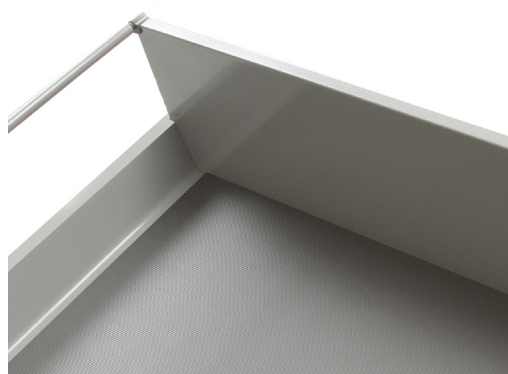

FUNDOS

FUNDOS DE ALUMÍNIO

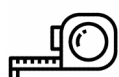
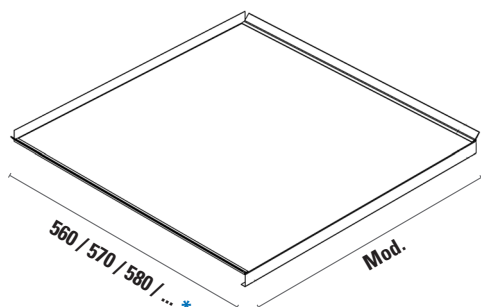
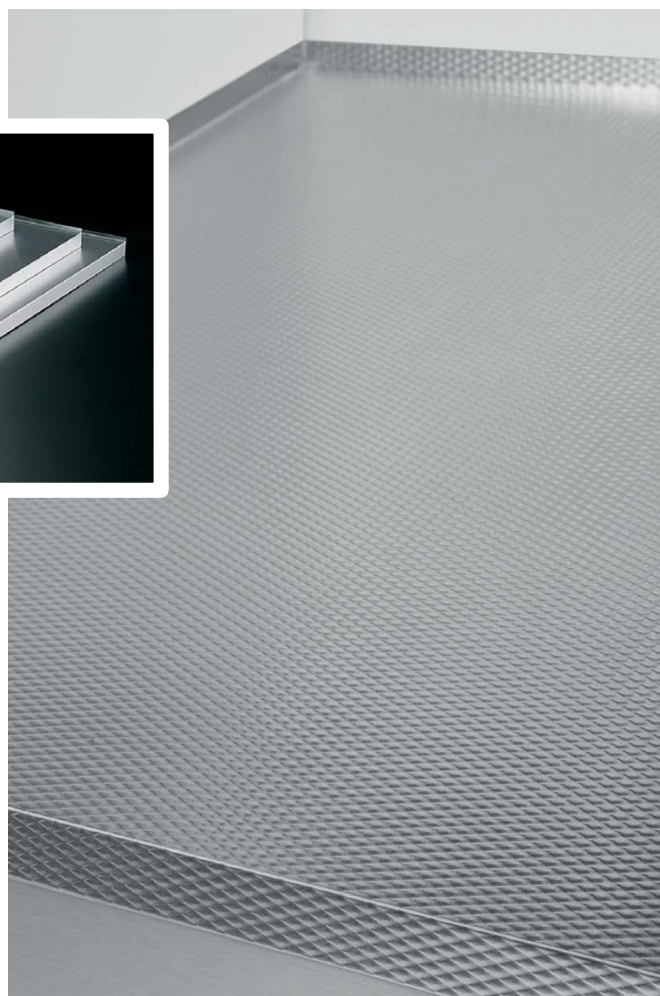

* Fazemos à medida dos seus móveis.

ILHARGA - 16mm

TAB.	MÓD.	ACAB.
C10A.18	400	Alumínio
C10A.19	450	
C10A.20	500	
C10A.21	600	
C10A.22	700	
C10A.23	800	
C10A.24	900	
C10A.25	1000	
C10A.26	1100	
C10A.27	1200	

ILHARGA - 19mm

TAB.	MÓD.	ACAB.
C10A.28	500	Alumínio
C10A.29	600	
C10A.30	700	
C10A.31	800	
C10A.32	900	
C10A.33	1000	
C10A.34	1100	
C10A.35	1200	

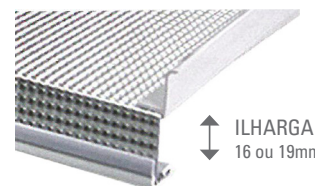

ILHARGA
16 ou 19mm



COM
VEDANTE

CORTA SIFÃO

CORTA SIFÃO FLEXÍVEL



TAB.	REF.	ESPESSURA	ACAB.
C10A.36	35/10.1660	16mm	Cinza

» Parafusos não incluídos.



VÍDEO



CORTA SIFÃO

TAB.	REF.	PROF.	ACAB.
C10A.37	FI-21960	197mm	Cinza
C10A.38	FI-21961	257mm	

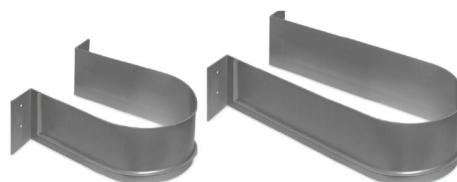
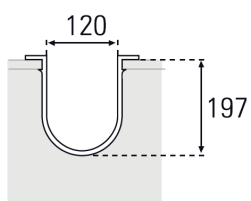
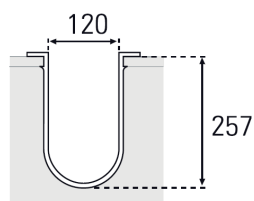

CORTA SIFÃO

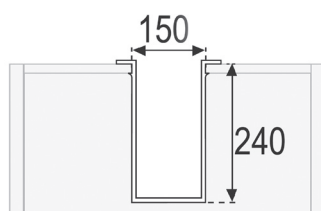
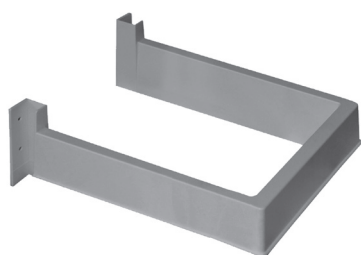

TAB.	REF.	ACAB.
C10A.39	FI-21952	Branco
C10A.40	FI-21953	Cinza

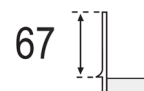

CORTA SIFÃO

CORTA SIFÃO COM DIVISÓRIAS

Gollinucci
DESIGNED FOR EVERY DAY



PROF. INFERIOR A 350mm

TAB.	REF.	PROF.	ACAB.
C10A.41	SS27V_AN	264mm	Antracite
C10A.42	SS27V_BR		Branco

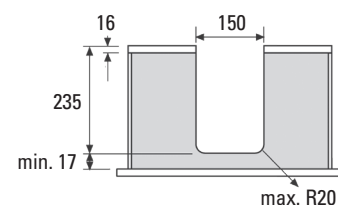
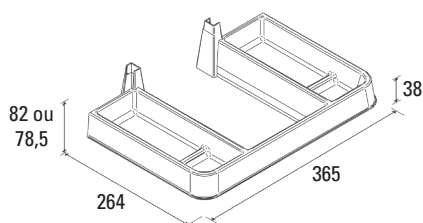

PROF. SUPERIOR A 350mm

TAB.	REF.	PROF.	ACAB.
C10A.43	SS35V_AN	321mm	Antracite
C10A.44	SS35V_BR		Branco

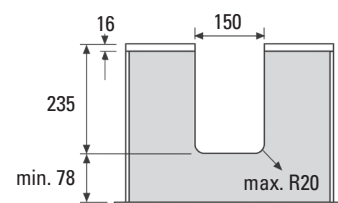
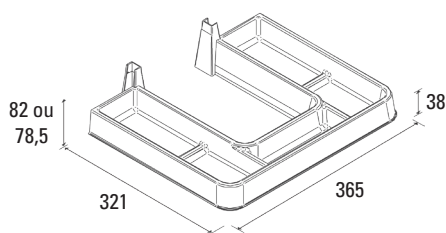

PERSIANA

PERSIANA DE ALUMÍNIO . LÂMINA 25mm

TUK

TAB.	KIT	900 ALT.	1200 ALT.	1470 ALT.	ACAB.
C10A.45	450	FI_P25_080	FI_P25_081	FI_P25_082	Branco Brilho
C10A.46	600	FI_P25_083	FI_P25_084	FI_P25_085	
C10A.47	900	FI_P25_086	FI_P25_087	FI_P25_088	
C10A.48	450	FI_P25_000_N	FI_P25_001_N	FI_P25_002_N	Cinza
C10A.49	600	FI_P25_003_N	FI_P25_004_N	FI_P25_005_N	
C10A.50	900	FI_P25_006_N	FI_P25_007_N	FI_P25_008_N	

> Para 16 e 19mm.

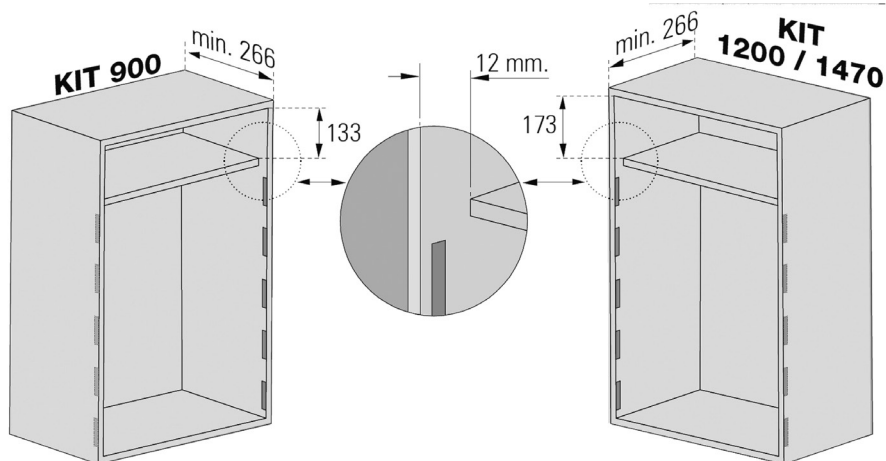
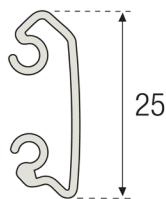
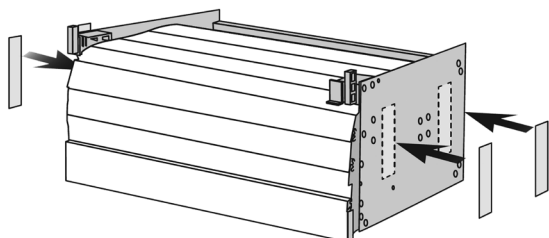

PERSIANA

PERSIANA DE ALUMÍNIO . LÂMINA 50mm

TUK

TAB.	KIT	900 ALT.	1200 ALT.	1470 ALT.	ACAB.
C10A.51	450	FI_P50_054	FI_P50_055	FI_P50_056	Branco Brilho
C10A.52	600	FI_P50_057	FI_P50_058	FI_P50_050	
C10A.53	900	FI_P50_059	FI_P50_060	FI_P50_061	
C10A.54	600	/	/	FI_P50_040	Cinza

> Para 16 e 19mm.

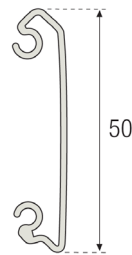
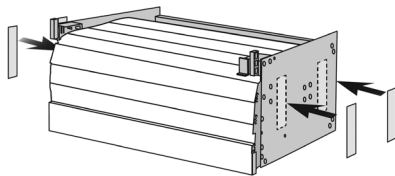

REGULAÇÃO

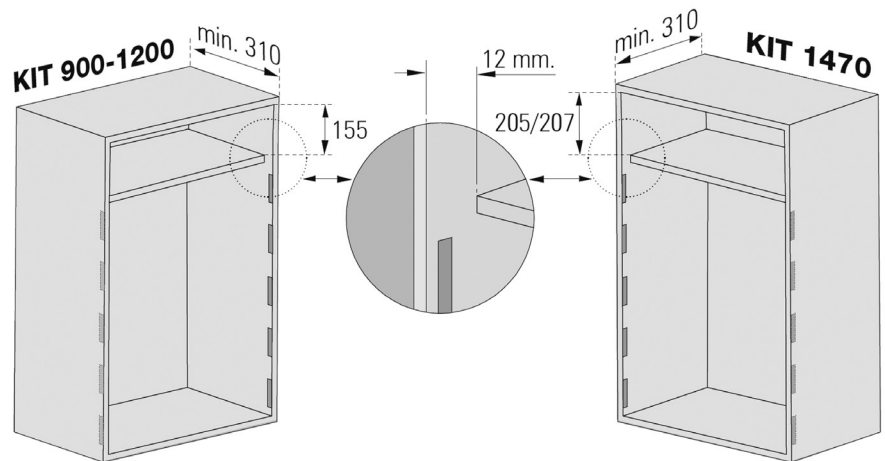
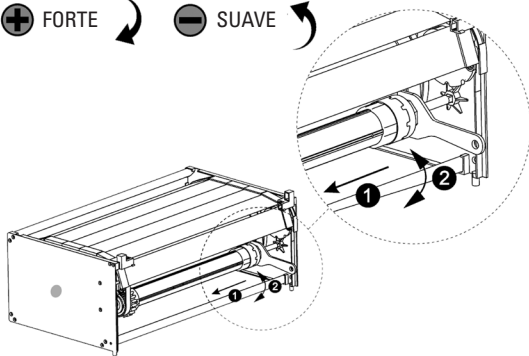

NIVELADORES



SCARPI-4

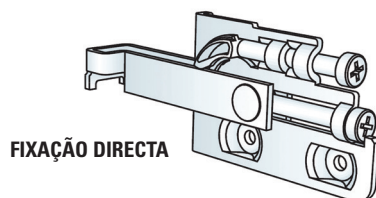
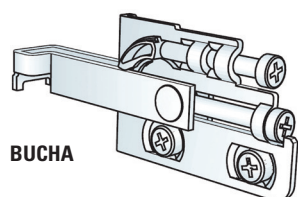
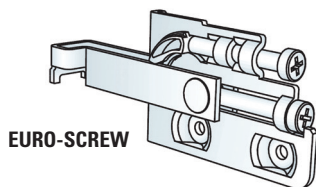

TAB.	MONTAGEM	LADO	REF.	CARGA	ACAB.
C10A.55	Euro-Screw	Esq.	625.000.036	até 260Kg.	Zincado
C10A.56		Dir.	625.100.033		
C10A.57	Bucha	Esq.	625.200.030		
C10A.58		Dir.	625.300.034		
C10A.59	Fixação Directa	Esq.	625.400.031		
C10A.60		Dir.	625.500.035		



VÍDEO

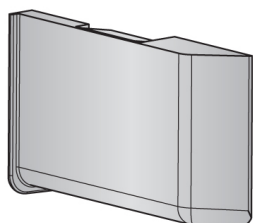

CAPAS

TAB.	LADO	REF.	ACAB.
C10A.61	Esq.	639.600.006	Branco
C10A.62	Dir.	639.700.003	RAL9001
C10A.63	Esq.	639.000.014	Castanho
C10A.64	Dir.	639.100.011	RAL8016
C10A.65	Esq.	639.600.146	Cinza
C10A.66	Dir.	639.700.143	RAL9006
C10A.67	Esq.	639.000.062	Niquelado
C10A.68	Dir.	639.100.066	

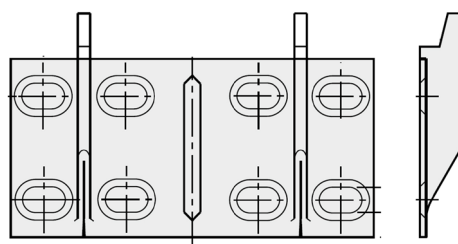

CHAPA DE FIXAÇÃO DUPLA

TAB.	MODELO	REF.	ACAB.
C10A.69	Chapa Dupla	623.000.033	Zincado

NIVELADORES

SCARPI-5

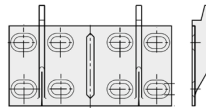
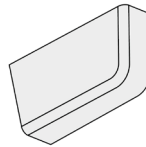
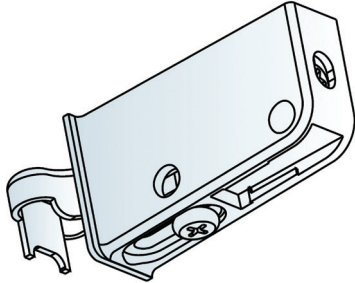

TAB.	MONTAGEM	LADO	REF.	CARGA	ACAB.
C10A.70	Fixação Directa	Esq.	626.200.002	até 260Kg.	Branco Ral 9001
C10A.71		Dir.	626.300.006		

CAPA

TAB.	LADO	REF.	ACAB.
C10A.72	Esq.	639.400.145	Cinza
C10A.73	Dir.	639.500.142	RAL9006

CHAPA DE FIXAÇÃO DUPLA

TAB.	MODELO	REF.	ACAB.
C10A.74	Chapa Dupla	623.000.033	Zincado

TRASER-6



MONTAGEM RÁPIDA

MONTAGEM DIRECTA



PARAFUSO

TAB.	MONTAGEM	LADO	REF.	CARGA	ACAB.
C10A.75	Rápida	Esq.	624.200.032	até 260Kg.	Zincado
C10A.76		Dir.	624.300.036		
C10A.77	Directa	Esq.	624.000.031		
C10A.78		Dir.	624.100.035		
C10A.79	Parafuso	Esq.	624.400.033		



CHAPA ENGATE DUPLO

TAB.	MEDIDA	REF.	ACAB.
C10A.80	182	621.901.033	Zincado

CAPA

TAB.	MEDIDA	REF.	ACAB.
C10A.81	Ø18,5x4,5	961.618.000	Br. RAL9001
C10A.82		961.618.066	Zincado



VÍDEO

NIVELADORES



SISTEMA ATLAS



VÍDEO

MÓDULOS INFERIORES SUSPENSOS

- » Sistema de fixação oculto.
- » Solução eficaz e segura de fixação à parede.
- » Fácil ajuste de 16mm.
- » Pode ser pré-montado para facilitar o transporte.

CHAPA SUPERIOR DE PAREDE . PEQUENA

TAB.	REF.	ACAB.
C10A.83	620.860.030	Zincado

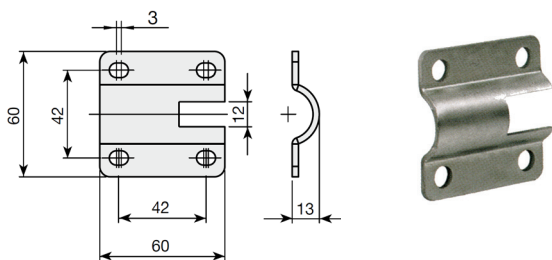

SUPORTE INFERIOR

TAB.	REF.	ACAB.
C10A.84	625.800.033	Zincado

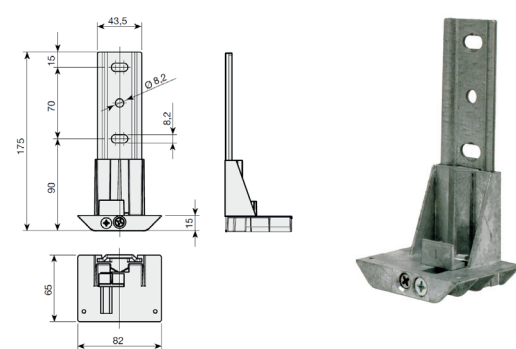

CHAPA SUPERIOR DE PAREDE . GRANDE

TAB.	REF.	ACAB.
C10A.85	620.913.031	Zincado

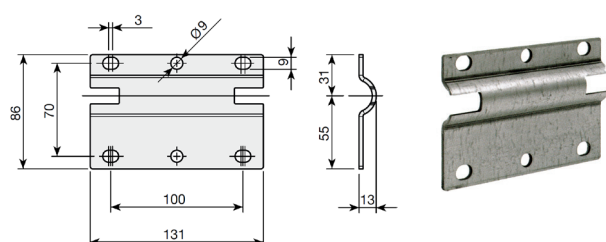

SUPORTE POSTERIOR SUPERIOR

TAB.	REF.	ACAB.
C10A.86	625.700.036	Zincado

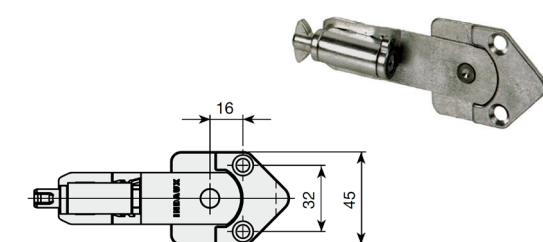

SUPORTES DE PRATELEIRA

TENTI - 8 . SUPORTE OCULTO LISO

TAB.	REF.	MEDIDA	ACAB.
C10A.87	632.500.105	112x82x20	Zincado

» cada conjunto contém 1 suporte + 4 tacos plástico e 4 buchas.

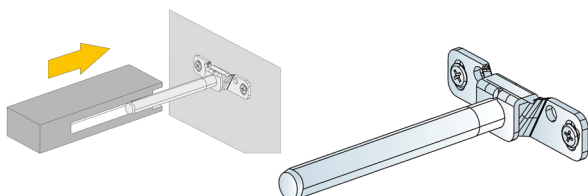

TENTI - 9 . SUPORTE OCULTO ROSCADO

TAB.	REF.	MEDIDA	ACAB.
C10A.88	633.612.103	115x80x41	Zincado

» cada conjunto contém 1 suporte + 2 tacos plástico e 2 buchas.

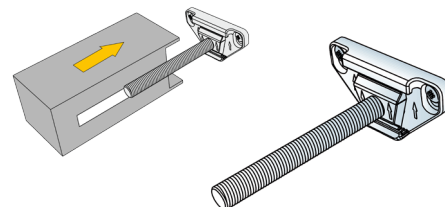

CLIP-SAFE . SUPORTE DE PRATELEIRA

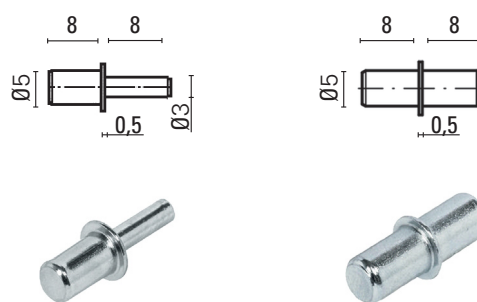
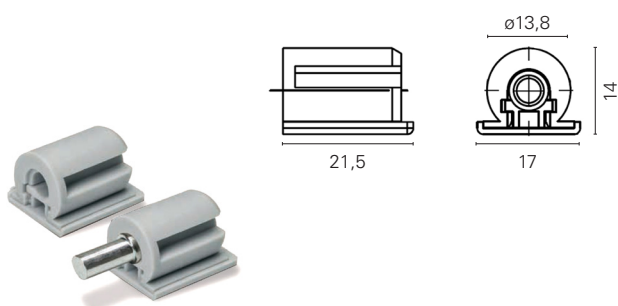
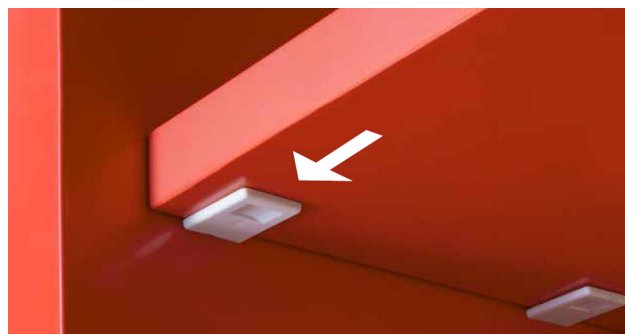
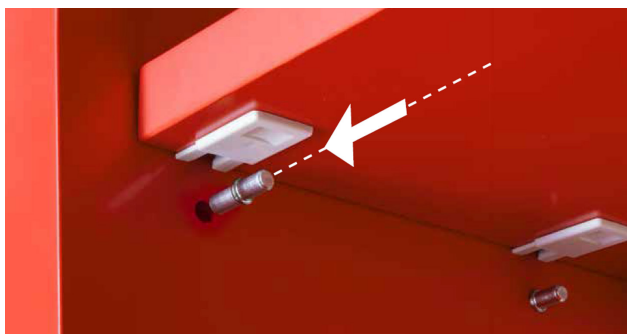

TAB.	ARTIGO	REF.	ACAB.
C10A.89	SUPORTE S/ PINO	01.0951	Branco
C10A.90		11.0951	Castanho
C10A.91		21.0951	Preto
C10A.92		51.0951	Cinza
C10A.93		71.0951	Antracite

TAB.	ARTIGO	MED.	ACAB.
C10A.94	PINO	Ø3/5mm	Galvanizado
C10A.95		Ø5/5mm	

SUPORTES DE PRATELEIRA



SUPORTE METÁLICO

TAB.	REF.	ARTIGO	ACAB.
C10A.96	80100005	Suporte c/ goma	Metal
C10A.97	80100006	Suporte s/ goma	

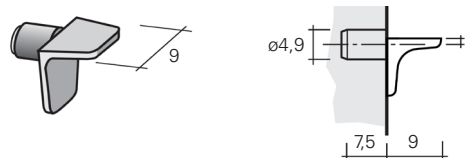

SUPORTE COM PINO DE Ø5

TAB.	REF.	MED.	ACAB.
C10A.98	80100001	Pino Ø5mm	Transparente

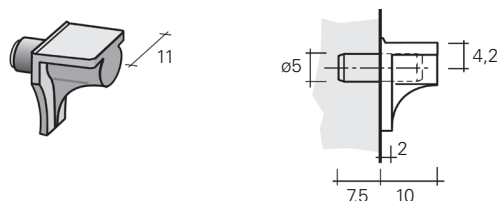

CAPAS E BATENTES

BATENTE DE BORRACHA

TAB.	REF.	MED.	ACAB.
C10A.99	80111004	Ø5mm	Transparente

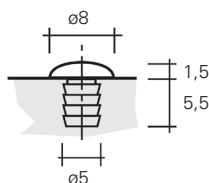

BATENTE DE PLÁSTICO C/ BORRACHA

TAB.	REF.	MED.	ACAB.
C10A.100	80111001	Ø5mm	Transparente

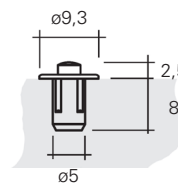





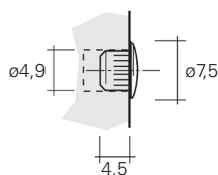











TAPA FUROS

TAB.	REF.	MED.	ACAB.
C10A.101	80122001		Branco
C10A.102	80122002	Ø4,9mm	Cinza claro
C10A.103	80122003		Antracite



CAPAS E BATENTES

CAPAS ADESIVAS - Ø13

			
Branco FI-13982	Branco "Sujo" FI-11164	Cinza Claro FI-93562	Cinza Escuro FI-93520
			
Cinza (Alumínio) FI-93336	Cinza Prata FI-SILVER01	Cerej. Clara FI-9117	Cerej. Escura FI-9118
			
Faia FI-374	Faia Vaporizada FI-260	Carvalho FI-4569	Nogueira Escura FI-6080
			
Wengue FI-994	Preto FI-657	Linho FI-21115	Linho Escuro FI-51117

TAB.	REF.	ACAB.
C10A.104	FI-13982	Branco
	FI-11164	Branco "Sujo"
	FI-93562	Cinza Claro
	FI-93520	Cinza Escuro
	FI-93336	Cinza (Alumínio)
	FI-SILVER01	Cinza Prata
	FI-9117	Cerej. Clara
	FI-9118	Cerej. Escura
	FI-374	Faia
	FI-260	Faia Vaporiz.
	FI-4569	Carvalho
	FI-6080	Nogueira Escura
	FI-994	Wengue
	FI-657	Preto
FI-21115	Linho	
FI-51117	Linho Escuro	



BATENTES - GOTAS

TAB.	REF.	COMP.	ACAB.
C10A.105	FI-071.000	Ø7x1,5	
C10A.106	FI-101.000	Ø10x1,5	Transparente
C10A.107	FI-103.000	Ø10x3	



ACESSÓRIOS DIVERSOS

PROTEÇÃO LATERAL - MÁQUINAS DE LAVAR

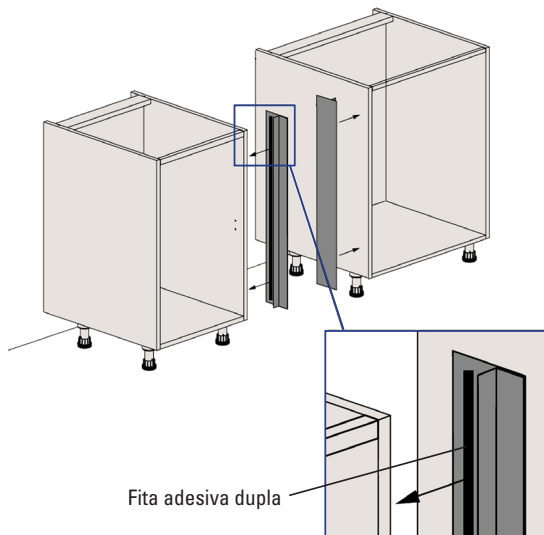

TAB.	REF.	ARTIGO			
		COMP.	LARG.	PROF.	ACAB.
C10A.108	40/78.2000.72P	720	60	12	Alumínio Anodizado
C10A.109	40/78.2000.78P	780			

» Inclui fita adesiva dupla.

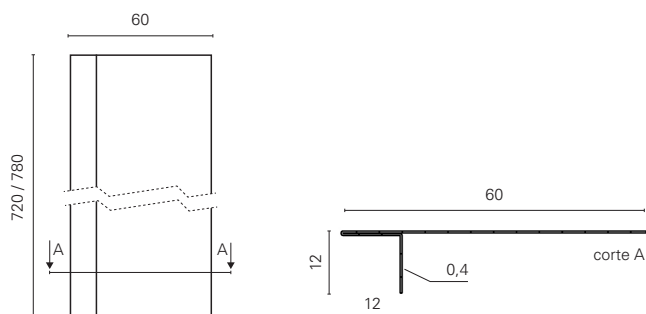

DOBRADIÇA DE CANTO



TAB.	REF.	ALT.	ACAB.
C10A.110	FI-700	700	Crom. Mate
C10A.111	FI-702		Inox
C10A.112	FI-701	900	Crom. Mate
C10A.113	FI-703		Inox

GRELHAS DE REFRIGERAÇÃO

TAB.	VARAS	MÓD.	ACAB.
C10A.114	6	600	Preto
C10A.115			Crom. Mate
C10A.116			Crom. Brilho
C10A.117			Inox

» 92mm de altura.

TAB.	VARAS	MÓD.	ACAB.
C10A.118	8	600	Preto
C10A.119			Crom. Mate
C10A.120			Crom. Brilho
C10A.121			Inox
C10A.122			Crom. Mate
C10A.123			Inox

» 124mm de altura.

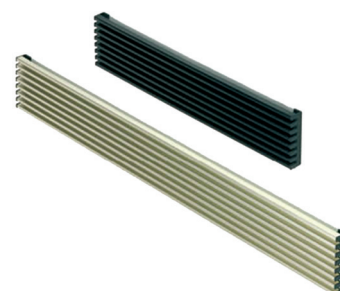

ACESSÓRIOS DIVERSOS

ESTABILIZADOR FRONTAL PARA GAVETA

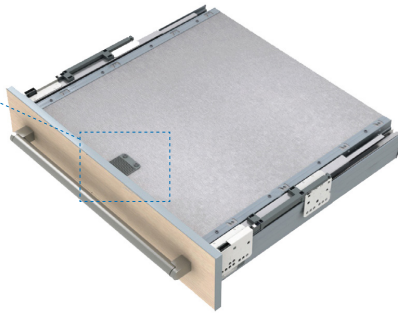
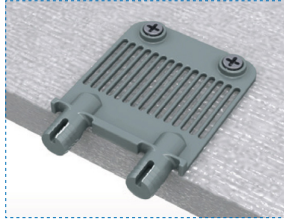

TAB.	REF.	MEDIDA GAVETA
C10A.124	FI_EST_31129	> 700mm

FRENTE DE GAVETA

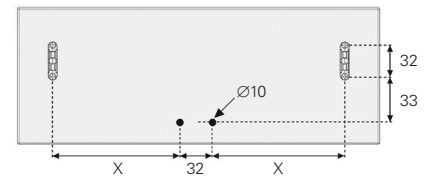

ESPAÇADORES 9mm . CORREDIÇAS

TAB.	REF.	ACAB.
C10A.125	FI_ESP_BR_9	Branco
C10A.126	FI_ESP_CZ_9	Cinza

» Fornecidos ao par.

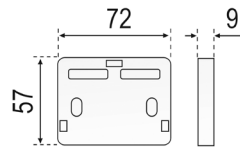

ESPAÇADORES 25mm . CORREDIÇAS

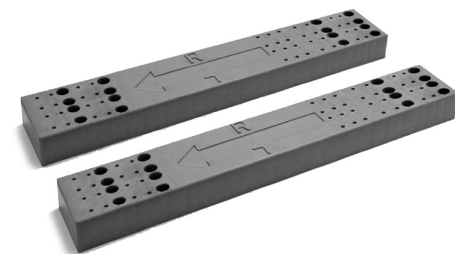

TAB.	REF.	ACAB.
C10A.127	FI_ESP_BR_25	Branco
C10A.128	FI_ESP_CZ_25	Cinza

» Fornecidos ao par.

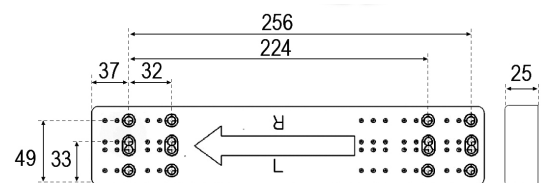

ACESSÓRIOS DIVERSOS

ESQUADROS

TAB.	REF.	MEDIDA	ACAB.
C10A.129	FI-21808	22x25x25mm	Zincado
C10A.130	FI-21809	50x20x20mm	



CANTONEIRA EM CARTÃO Prensado



TAB.	MEDIDA	ESPESSURA	ACAB.
C10A.131	32x32x4085	2,75mm	Natural

» Este artigo tem de ser adquirido em atados de 25 Bar.